

**Introduction**

Congratulations on the purchase of your new **WireMac-EX**, a Professional and Heavy-Duty Wire Punch and Binding Machine. Your **WireMac-EX** was designed with a full range of functions and premium quality components to guarantee you an effortless and professional bind, as well as many years of trouble-free service.

**Important**

We recommend that you take a few minutes to familiarize yourself with the functions of your new machine. You will find that with just a little practice, any person can achieve professional results.

**Features**

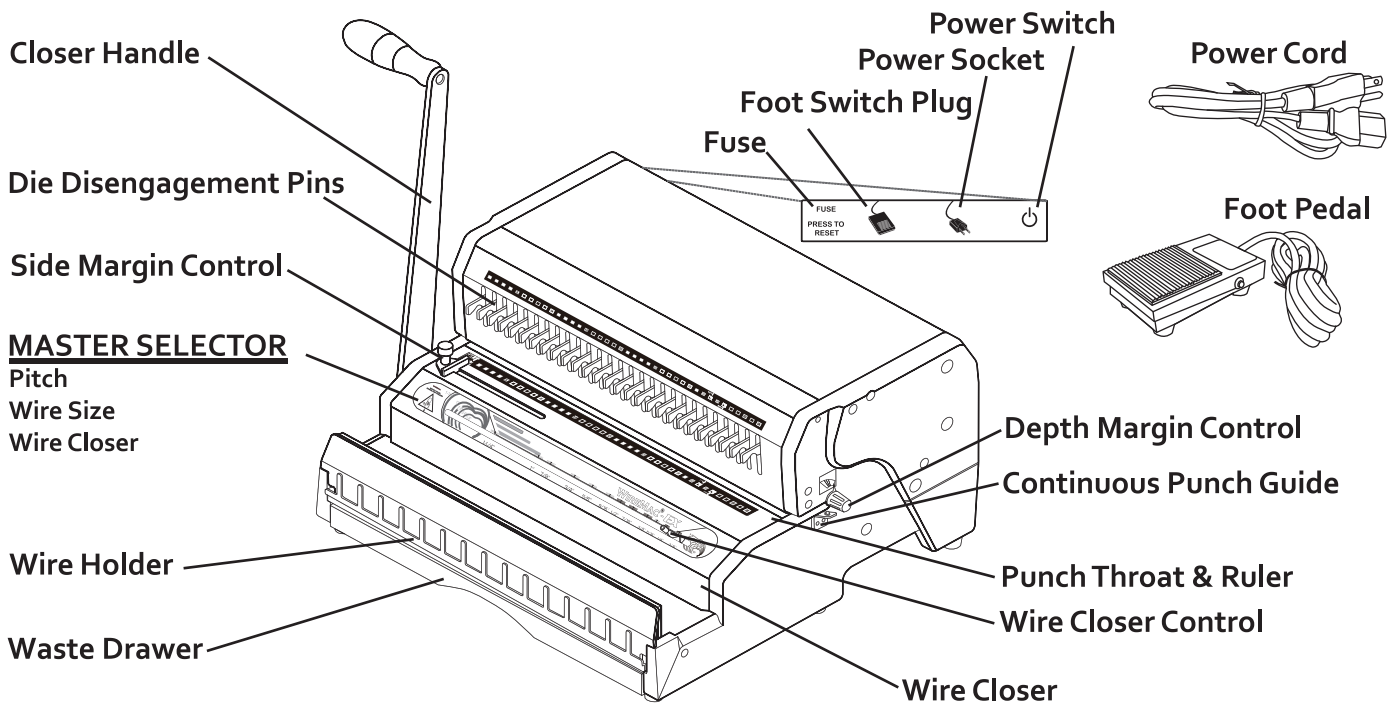

**Assembly**

1. Place your new **WireMac-EX** on top of a sturdy working table (Picture 1).
2. Plug the power cord and foot pedal into the back of the machine (Picture 2).
3. Attach the Closer Handle to the Closing Axle and screw the handle screw into the Closing Axle (Picture 3).  
 Note: The handle screw is reverse threaded and must be turned counter-clockwise to tighten.
4. Turn on the power switch and place the foot pedal on the floor (Picture 4).

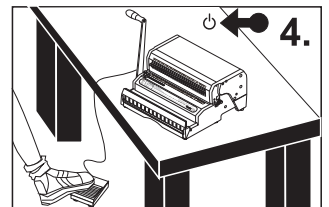
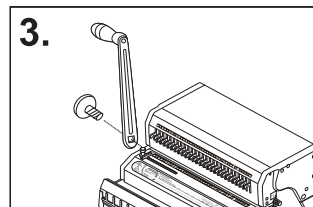
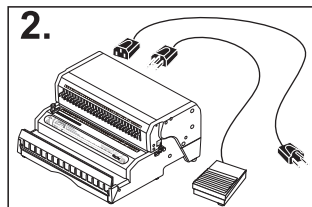
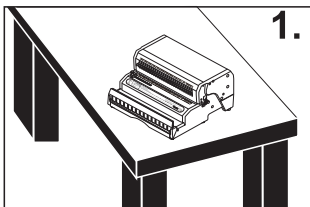

**Safety Instructions**

- \* Always turn off the machine and place the foot pedal out of reach when machine is not in use.
- \* To reduce the risk of electrical shock, never operate the machine near water.
- \* Do not use the machine if the power cord is damaged.
- \* Do not allow the electrical cord to be in contact with hot surfaces.
- \* In case of malfunction, please contact your dealer for technical support.

# Setup

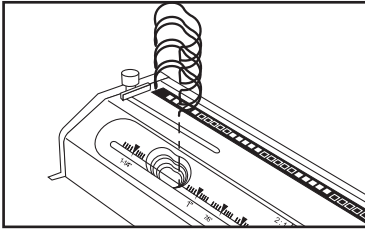

1. If you do not know the size of your wire, use the **Master Selector** to identify the size of your wire.

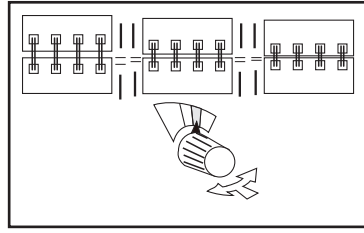

2. Push and turn the **Depth Margin Control** to 1 of 4 colors depending on the size of your wire.

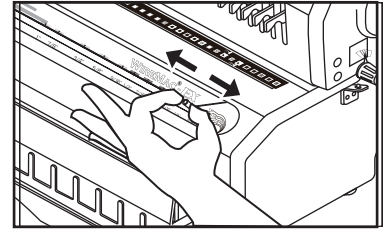

3. Slide the **Wire Closer Control** left or right to the correct wire closure size determined in Step 1.

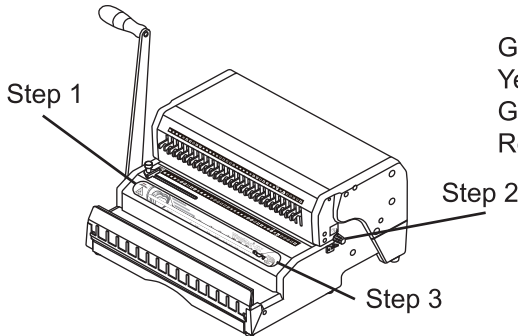

Green: 3/16" - 5/16" wire  
 Yellow: 3/8" to 1/2" wire  
 Gray: 9/16" to 1-1/4" wire  
 Red: 1-1/2" and larger

# Punching

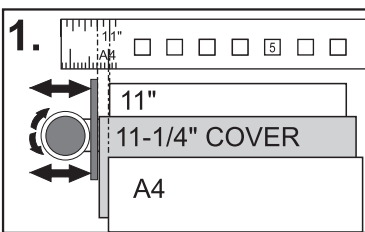

1. Align **Side Margin Control** to proper sheet and cover size.  
 Note: There are different side margins for 11" sheets & their 11-1/4" covers.

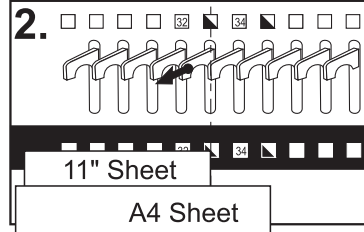

2. Pull out **Disengagement Pins** to avoid partially punched holes.

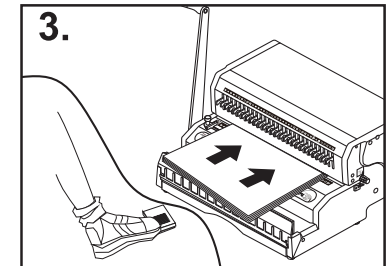

3. Insert sheets and press foot pedal to punch.

## For Documents Larger than 14" (356 mm)

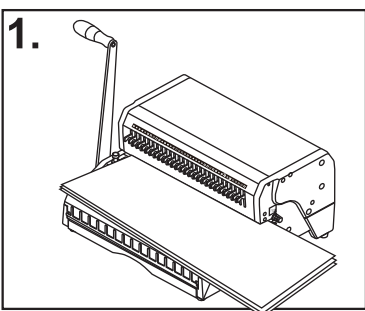

1. Align sheets as indicated on punch throat ruler. Insert sheets and press foot pedal to punch the left side first.

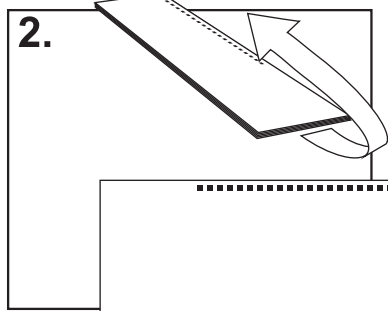

2. Remove the sheets and flip them over as illustrated. The punched holes should now be on your right side.

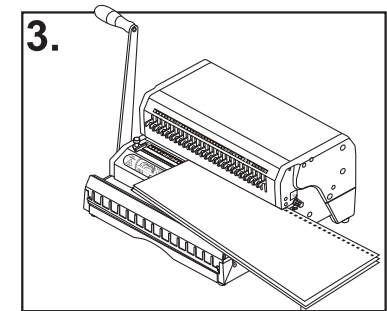

3. Insert the sheet from the right hand side and put the **Continuous Punch Guide** alignment knob into one of the holes. Now press the foot pedal to punch the holes on the left.

### TIPS

Maximum single punching capacity is **25 sheets** (20 lb paper).  
 Recommended number of sheets per punch (for maximum equipment durability): 20 sheets (20 lb paper).  
 Empty the waste drawer from time to time. An overfilled waste drawer may cause the machine to malfunction and void your warranty.

## IN CASE OF PAPER JAM

The punch cycle will automatically stop when the machine is overloaded with too many sheets. When this occurs, please use the manual jam release.

1. Shut off the power switch.
2. Insert a 6 mm Allen key (not included) into the hole in the left side panel of the machine (Picture A).
3. Rotate the Allen key counter clockwise to pull the punch pins out of the sheet (Picture B).
4. Remove all sheets from the punch throat.
5. Remove Allen key from the machine, then turn ON the power and press the foot pedal to make sure machine operates correctly.

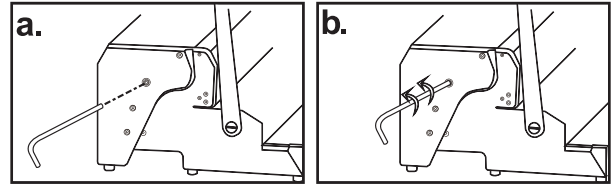

## Inserting

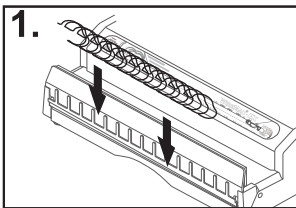

1. Insert pre-selected wire into the **Wire Holder**.

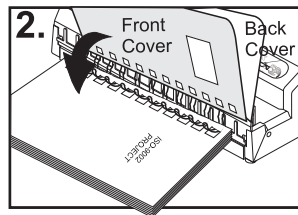

2. Insert document from the last pages to the first, with the front cover and the back cover inserted last.

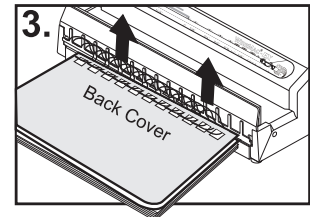

3. Take out the inserted document from the **Wire Closer** to close the wire.

## Closing

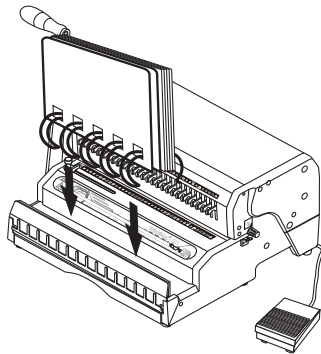

1. Put inserted document into the **Wire Closer**. Make sure the wire element stands horizontally at the bottom of the Wire Closer.

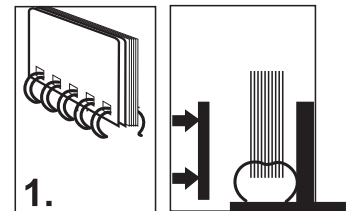

2. Pull the **Closer Handle** towards you to close the wire.

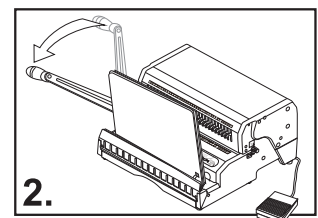

3. Take the document out of the **Wire Closer** and turn the back cover over. Your binding is now complete.

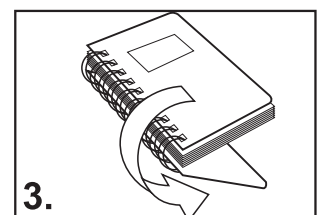

### TIPS

The seam of the closed wire should be inside the back cover of the book.

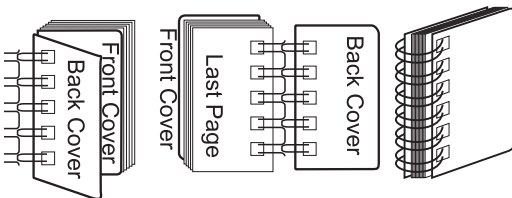

### TIPS

The seam of the closed wire should be just touching. If the wire looks under closed or over closed, slightly adjust the **Closer Control** to the left or right.

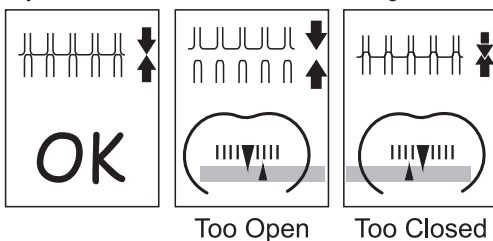

# Maintenance

It is recommended you lubricate the punching blades inside the machine 1-2 times a year depending on use.

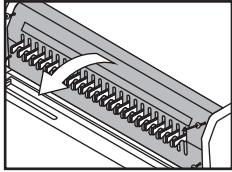

1. Take off the front cover of the machine by first removing the 4 screws.

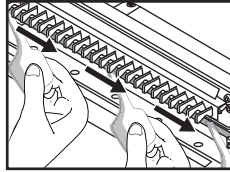

2. Lubricate the punching blades with lithium or synthetic grease.

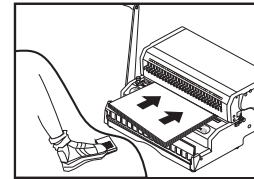

3. Punch scratch paper or paper towels to get rid of excess residue.

# Technical Information

Size (R)	Size 3 : 1 ( 3 HOLES PER INCH )				Size 2 : 1 ( 2 HOLES PER INCH )							
	■	■	■	■	■	■	■	■				
Punching Length	14"	LEGAL	A4	11"	8.5"	A5	14"	LEGAL	A4	11"	8.5"	A5
	= 40 Holes	= 38 Holes	= 34 Holes	= 32 Holes	= 24 Holes	= 24 Holes	= 27 Holes	= 26 Holes	= 23 Holes	= 21 Holes	= 16 Holes	= 16 Holes
Binding Capacity	Sheets 70-80 g/m <sup>2</sup>	Diameters			Sheets 70-80 g/m <sup>2</sup>	Diameters						
		Inch	mm			Inch	mm					
	20	3/16	4.5		140	5/8	16					
	30	1/4	6		160	3/4	19					
	50	5/16	8		190	7/8	22					
	60	3/8	9		220	1	25					
	80	7/16	10		280	1-1/4	32					
	100	1/2	12									
120	9/16	15										

# Warranty Policy

Your machine has a warranty of one year from the date of purchase. In the event of a manufacturer's defect, your distributor will repair or replace the machine at their option. This warranty does not cover damages due to improper use or mis-treatment of the unit, including any extraordinary event leading to the damage of the machine, whether it is reversible or not.

If the machine is not working properly, please contact your dealer for technical support. Please have your machine's serial number and purchase date ready. If the machine must be returned for repair, it is your responsibility to properly pack and ship the machine as any damage incurred during its transportation is not covered by our warranty policy.