

WIREMAC OPERATION MANUAL

INTRODUCTION:

CONGRATULATIONS ON THE PURCHASE OF YOUR NEW WIREMAC, A PROFESSIONAL AND HEAVY-DUTY WIRE PUNCH AND BINDING MACHINE. YOUR WIREMAC WAS DESIGNED WITH A FULL RANGE OF FUNCTION AND PREMIUM QUALITY COMPONENTS TO GUARANTEE YOU AN EFFORTLESS AND PROFESSIONAL BIND, AS WELL AS MANY YEARS OF TROUBLE-FREE SERVICE.

IMPORTANT:

WE RECOMMEND THAT YOU TAKE A FEW MINUTES TO FAMILIARIZE YOURSELF WITH THE FUNCTIONS OF YOUR NEW WIREMAC. YOU WILL FIND THAT WITH JUST A LITTLE PRACTICE, ANY PERSON CAN ACHIEVE PROFESSIONAL RESULTS.

WARRANTY:

YOUR WIREMAC HAS A ONE YEAR WARRANTY, FROM ITS PURCHASE DATE. IN THE EVENT OF A MANUFACTURERS DEFECT, YOUR DISTRIBUTOR MAY REPAIR OR REPLACE IT. IMPORANT: THIS WARRANTY DOES NOT COVER DAMAGES DUE TO IMPROPER USE OR MISTREATMENT OF THE UNIT, INCLUDING ANY EXTRAORDINARY EVENT LEADING TO DAMAGE OF THE MACHINE, WHETHER IT IS REVERSIBLE OR NOT.

IF THE WIREMAC IS NOT OPERATING PROPERLY, FIRST FOLLOW THE OPERATIONAL MANUAL INSTRUCTIONS. IF THE PROBLEM PERSISTS, PLEASE CONTACT YOUR DEALER FOR FURTHER INSTRUCTIONS. PLEASE HAVE YOUR MACHINES SERIAL NUMBER AND THE PURCHASE DATE READY. IF THE MACHINE MUST BE RETURNED TO YOUR DISTRIBUTOR, IT IS YOUR RESPONSIBILITY TO PROPERLY PACK AND SHIP IT. AS ANY DAMAGES INCURRED DURING ITS TRANSPORTATION ARE NOT COVERED BY OUR WARRANTY POLICY.

FEATURES

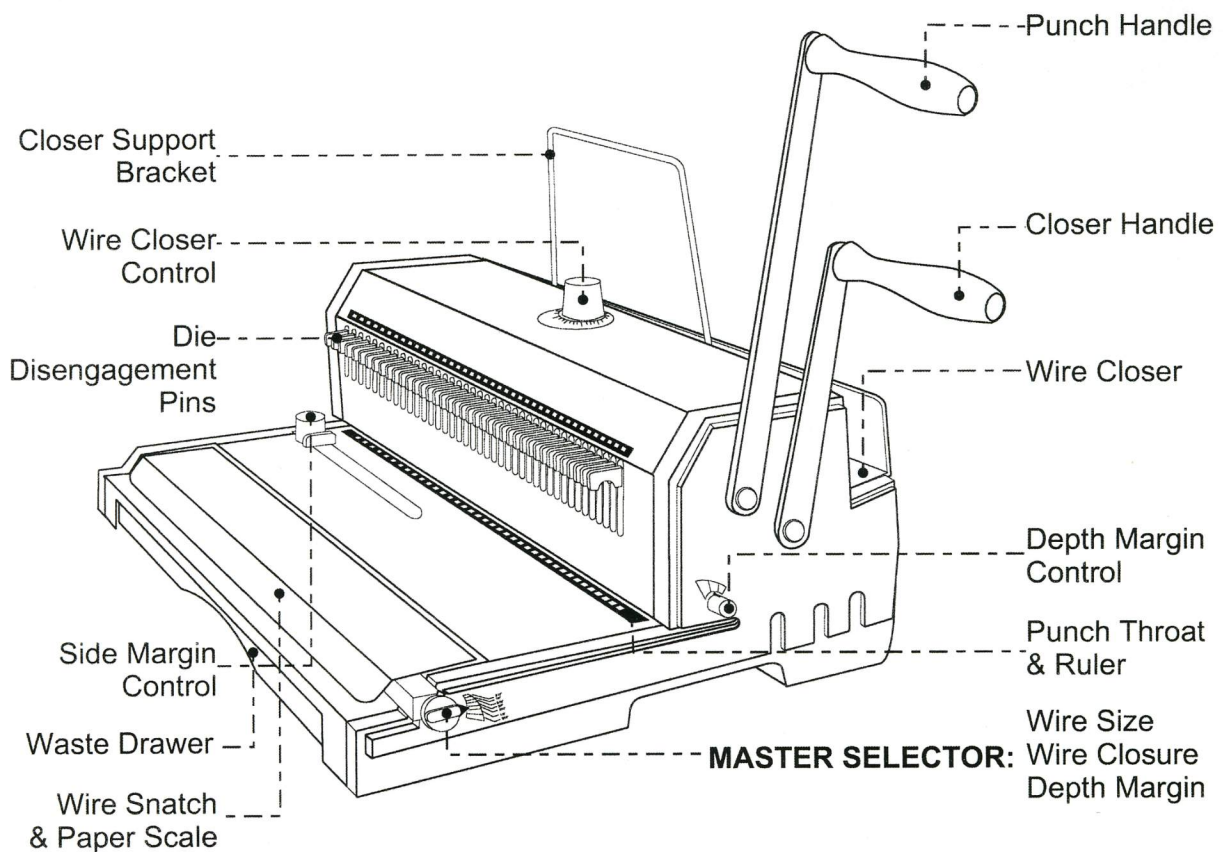

ASSEMBLY

Place Your New WireMac
On top Of A Sturdy Working Table.

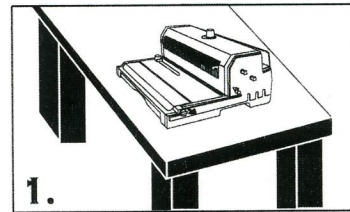

Remove The Screw From Punching Axle
Connect The Punch Handle (The Longer One)
In A Vertical Position Onto The Punching Axle.
Tighten-Back The Screw Onto The Punching Axle.

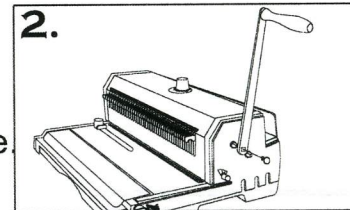

To Set-Up The Closer Handle
Repeat Above Steps With Closer Axle
& Handle

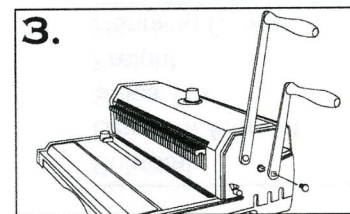

SET-UP

Insert Your Full Unbound
Document Into
Wire Snatch.

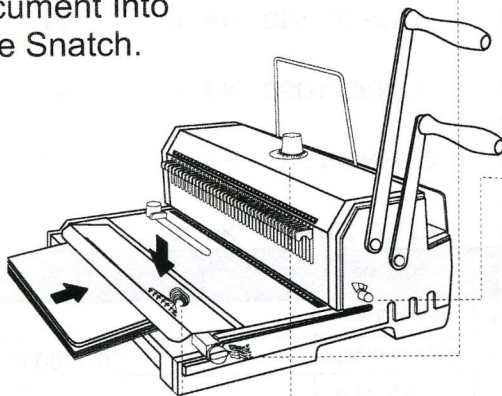

Read The Master Selector
To Determine The Correct:
Depth Margin
Wire Size
Wire Closure

Set Margin Control To
The Color Determine
Depth Margin.
(Color Indicated On Master
Selector Should Match Color
On Margin Contorl)

Set Wire Closer Control
To The Determined
Wire Closure Size.

Read The Determined
Wire Size And Set Aside.

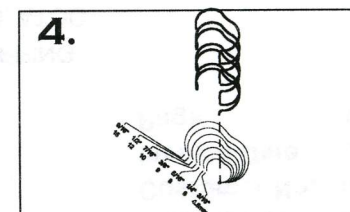
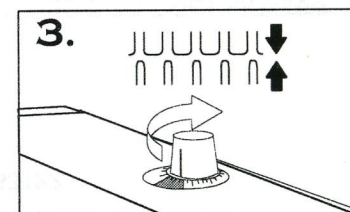
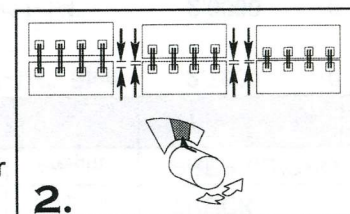
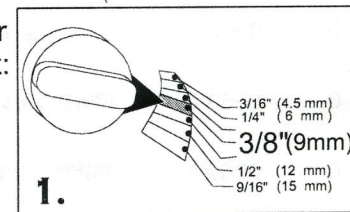

PUNCHING

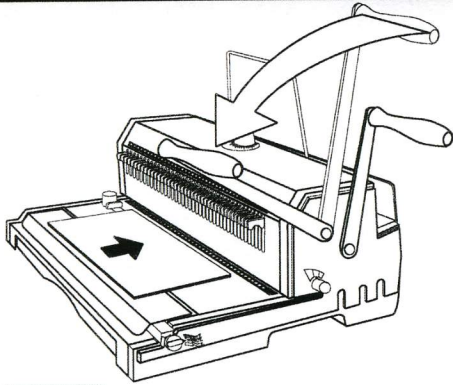

Move Side Margin Control To Proper Sheet & Cover Size.

Note There Are Different Side Margins For 11" Sheets & Their 11-1/4" Covers.

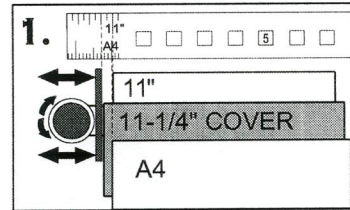

Pull Out Disengagement Pins For Partially Covered Holes.

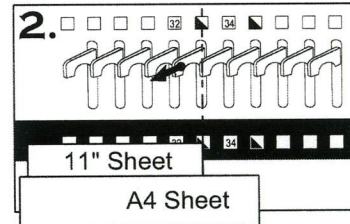

TIPS

Maximum Single Punching:
20 Sheets Of 20 Lbs
or 70-80g/m Paper.

Comfortable Single Punching:
12-15 Sheets Of 20 Lbs
or 70-80 g/m Paper.

Punch Inner Sheets And
Cover Separately As Side Margin
May Vary.

Re-Align (Center) Margins
For Oversize Covers.

Insert Sheets And
Pull Handle Forward
To Punch.

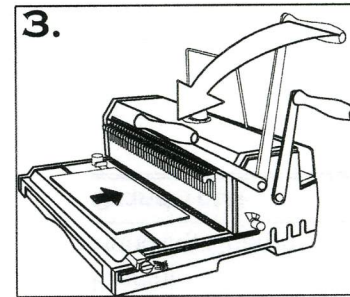

INSERTING

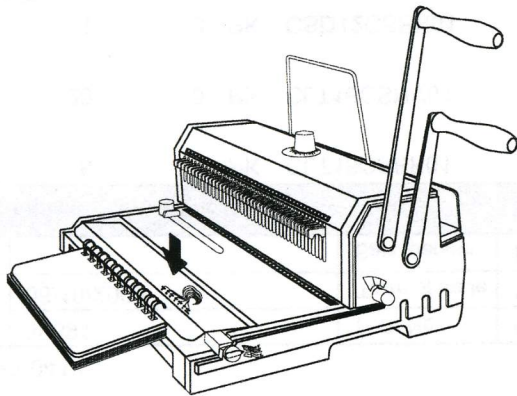

Insert Pre-Selected Wire
Into Wire Snatch

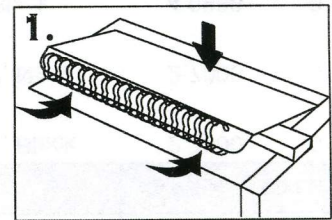

Insert Document From
Last Pages To First
Pages Then Insert Front
Cover.

The Back Cover Should
Be Inserted Last With
Inside Facing Up.

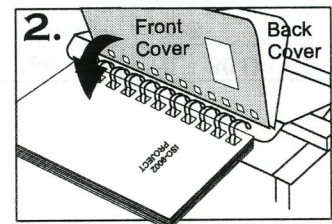

Take Out Inserted
Document From
Wire Snatch To
Close The Wire.

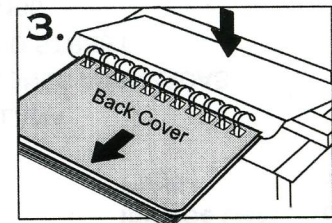

TIPS

The Seam Of Closed Wire Should Be Inside The Book.
Follow Step No.2 Instruction For Best Results.

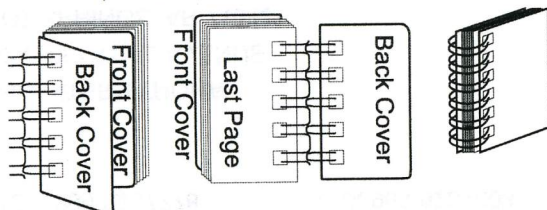

CLOSING

Raise Up Closer Support Bracket To Hold Document.

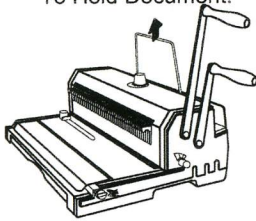

Put Inserted Document Into Wire Closer.

The Wire Element Must Stand Horizontally At The Bottom Of Closer.

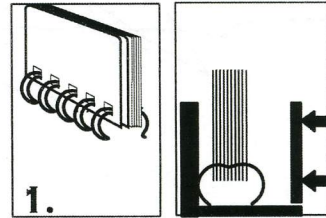

TIPS

The Seam Of Closed Wire Should Be Just Touching. Slightly Adjust The Closer Control For The Under-Closed Or Over-Closed Seam.

Pull Closer Handle Forward To Close.

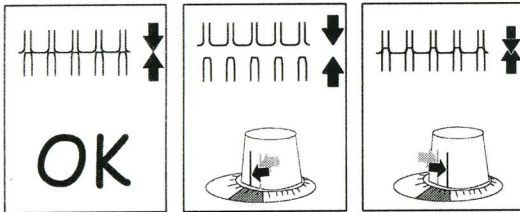

Properly Closed

Under Closed. Adjust Control Clockwise A Few Grids.

Over Closed. Adjust Control Counter-Clockwise A Few Grids.

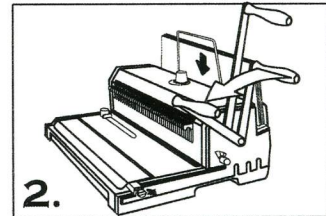

Take Out Document And Turn Back Cover Over. The Binding Is Ready.

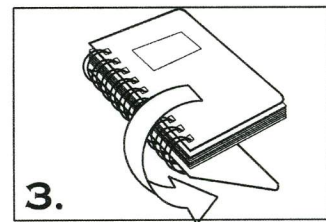

TECHNICAL INFORMATION

Model	WIREMAC 31 Pitch 3 : 1		WIREMAC 21 Pitch 2 : 1	
	■ ■ ■ ■ ■ ■ ■ ■		■ ■ ■ ■ ■	
Punching Length	14" = 40 Holes	LEGAL = 38 Holes	14" = 27 Holes	LEGAL = 26 Holes
	A4 = 34 Holes	11" = 32 Holes	A4 = 23 Holes	11" = 21 Holes
	8.5" = 24 Holes	A5 = 24 Holes	8.5" = 16 Holes	A5 = 16 Holes
Binding Capacity	Sheets 70-80 g/m ²	Diameters Inch mm	Sheets 70-80 g/m ²	Diameters Inch mm
	20	3/16" 4.5	140	5/8" 16 mm
	30	1/4" 6	160	3/4" 19 mm
	50	5/16" 8	190	7/8" 22 mm
	60	3/8" 9	220	1" 25 mm
	80	7/16" 10	280	1-1/4" 32 mm
	100	1/2" 12		
	120	9/16" 15		