

FINITURA
FINISHING AT ITS FINEST

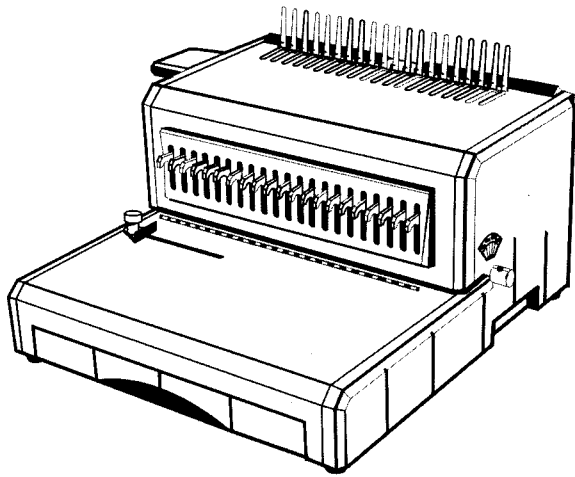

AlphaBind COMB BINDING SYSTEM

OPERATIONAL MANUAL



**AlphaBind-CE
ELECTRIC MODEL**

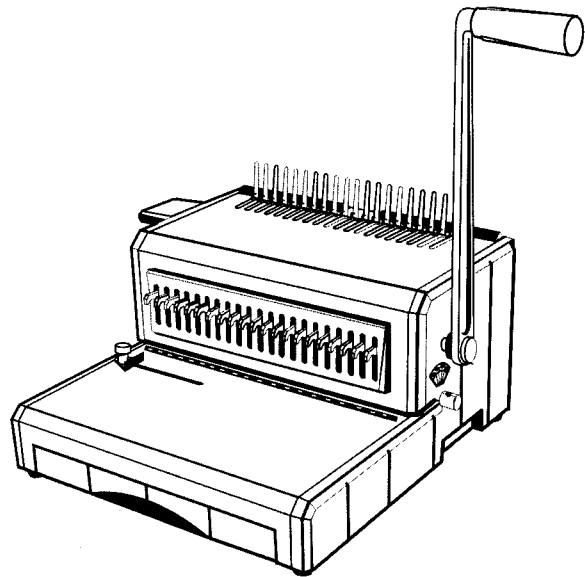

**AlphaBind-CM
MANUAL MODEL**

ASSEMBLY & SAFETY INSTRUCTIONS

1) Place your new **AlphaBind** on top of a sturdy work table.

For Electric model only (For manual model skip to step 5)

2) Place the FOOT PEDAL on the floor in front of the machine.

3) Plug power cord into the back of the machine.

4) Plug the other end of POWER CORD into an outlet with the correct voltage and type.

Warning: Powering the machine with incorrect voltage may severely damage its electrical components and result in personal injury!

IMPORTANT SAFETY GUIDELINES

A) Always turn main power switch OFF and place foot pedal out of reach before setting up, performing maintenance or when your **AlphaBind** is not in use.

B) To reduce the risk of electrical shock:

* Never operate the **AlphaBind** near water

* Do not use the **AlphaBind** if the power cord is damaged.

* Do not allow the electric cords to be in contact with hot surfaces.

For Manual model only (If Electric model skip step 6)

5) Attach the punching handle:

A) Slide the Punching handle and screw on to the punching axle. **See picture A**

B) Tighten the screw
See picture B

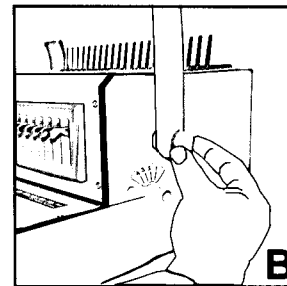
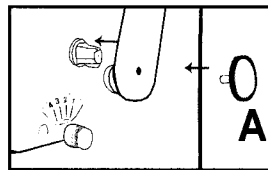

6) Attach Comb Opener Handle.

GENERAL SAFETY GUIDELINES

A) Contact your dealer in case of malfunction or for after sale service. Never try to repair the unit by yourself. The **AlphaBind** does not contain any part that can be serviced by the operator.

B) Empty waste bin regularly.

C) Lubricate punching dies as needed.

D) Never attempt to punch more than maximum number of sheets recommended. Doing so may cause severe damage to the equipment and fatigue to the operator.

PUNCHING

IMPORTANT:

- Always do test punch with waste paper to make sure document will be properly punched (Margins are evenly centered and holes are not being partially perforated).
- Maximum single punching:
Electric model: 20 sheets of 20lbs paper.
Manual model: 25 sheets of 20 lbs paper.
- Recommended comfortable single punching:
Electric model: 18-20 sheets of 20lbs paper.
Manual model: 12-16 sheets of 20lbs paper.
- Punch inner sheets and covers separately as side margin may vary
- Re-align margins for oversize covers.

1. Turn power on. **See picture 1 (for electric version only)**

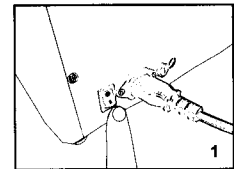

2. Align the Side Margin Control to the correct position according to the sheet or cover size. Note: Use ruler guide for proper alignment. **See picture 2**

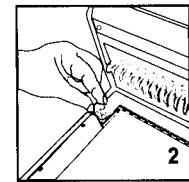

3. Push-in and rotate Depth Margin Control to the desired position (1, 2, 3 4). **See Picture 3**

Tip: Recommended depth margin per comb size:

Position 1: Small size comb (3/16" to 1/2")

Position 2: Mid size comb (7/16 to 7/8")

Position 3: Mid size comb (3/4" to 1")

Position 4: Large size comb (1-1/8 to 2")

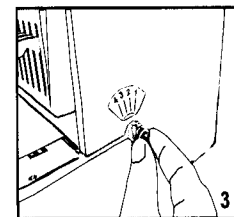

4. Pull out Disengagement Pins to avoid partially perforated holes (if needed). **See Picture 4**

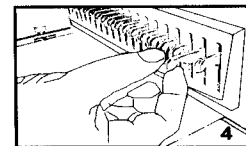

5. Insert sheets into the Punch Throat. **See Picture 5**

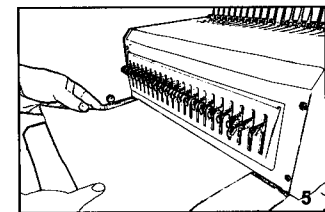

6. Activate the punching action by stepping on the foot pedal (for electric version) or by pulling the handle down (for manual version). **See Picture 6A and 6B**

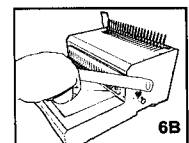
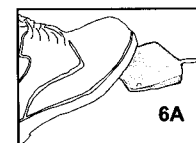

7. Repeat step 5 & 6 until all sheets have been punched.

BINDING

1. Place pre-selected comb behind Comb Opener Fingers.

Note: The comb opening side should be upward. **See picture 1**

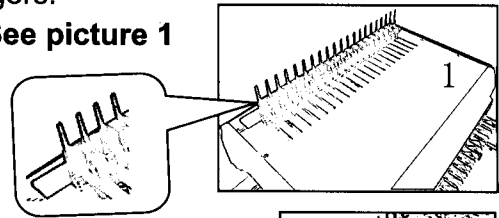

2. Gently rotate Comb Opener Handle clockwise to open comb.

Note: Open comb sufficiently to allow pages and covers to be inserted. **See picture 2**

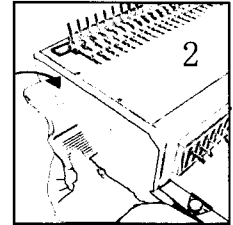

3. Align and insert punched pages onto comb fingers.

See picture 3

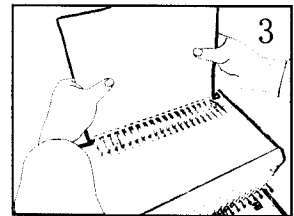

4. Gently rotate Comb Opener Handle counter-clockwise to close comb.

See picture 4

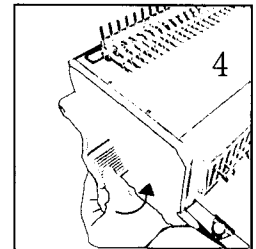

5. Lift the bound document upward, and remove it from Comb Opener Fingers. **See picture 5**

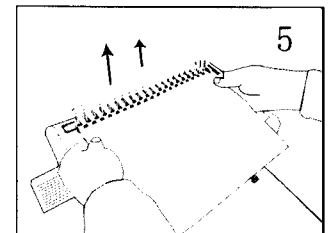

Congratulations the comb binding is complete

PUNCH DIE MAINTENANCE

To keep your *AlphaBind* running in optimal condition at all times, Punch Die lubrication should be performed on a regular basis.

How to lubricate Punch Dies

1. Remove front Punch Die Cover (use a Philip screw driver to loosen the 4 screws). **See Picture # 1**

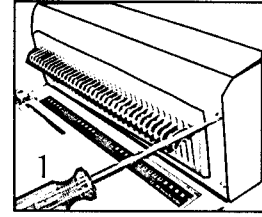

2. Apply die lubricant (with brush or by Slight Spray). **See picture 2**

Tip: Only a very small amount of die lubricant should be applied (with brush preferably) to avoid over spraying them

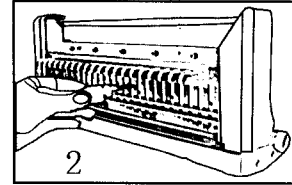

3. Screw back front Punch Die Cover. **See picture 3**

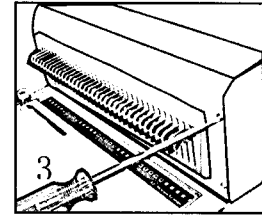

4. Remove any excessive lubricant by punching some scratch paper.

WARRANTY POLICY

*Your AlphaBind has a 1-Year limited Warranty from date of purchase.
If you have questions or need assistance, contact Finitura Service Department.*

FINITURA
FINISHING AT ITS FINEST
"your authorized dealer"
800-886-2463
www.finitura.com