

FORMAX[®]

Cut-True 13M Manual Paper Cutter

TABLE OF CONTENTS

TOPIC	PAGE
Specifications	1
Safety Guidelines	1
Assembly	2
Overview	3
Description of Equipment Parts	4
Operation	5-6
Maintenance	7
Replacing the Cutting Stick	7
Cutting Blade Maintenance	7
Replacing the Cutting Blade	8 - 9

Cut-True 13M Guillotine Cutter



SPECIFICATIONS

Cutting Action:	Manual lever handle
Maximum Cutting Width:	14.567"
Maximum Paper Stack Height:	.75"
Cutting Length Behind Blade	10.5"
Narrow Cut	1.25"
LED Laser Cut Line:	Yes
Clamp Style:	Lever
Back Gauge Adjustment:	Thumbscrew
Back Gauge Reading:	Scale, in both inches and metric
Blade Change Tool:	Included
Dimensions:	12.75" H x 18.75" W x 17.5" L
Weight:	38 lbs.

SAFETY GUIDELINES

- * Operators should read this manual prior to using the cutter
- * The Cut-True 13M should only be used by one person at a time.
- * The blade lever should be lowered using both hands.
- * After making each cut, the blade lever should be moved back to the full upright and locked position.
- * Do not disassemble the front Plexiglas safety cover.
- * Do not grasp underneath the blade edge.
- * When changing the blade, carefully follow the instructions in this manual, and be sure to use the supplied Blade Change Safety Tool.

ASSEMBLY

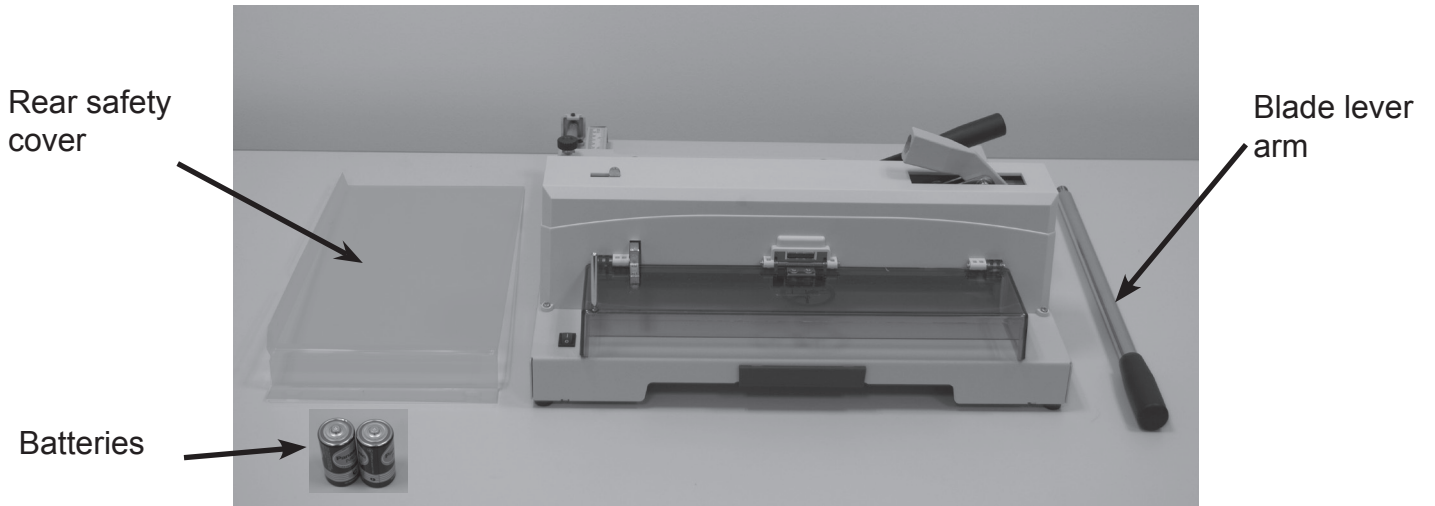

Rear Safety Cover

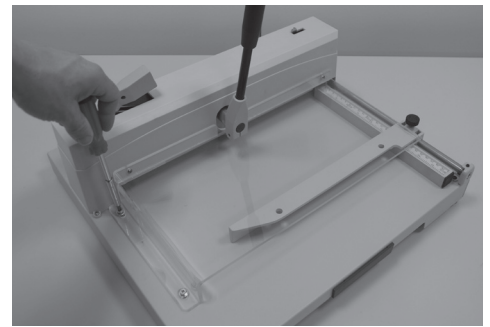
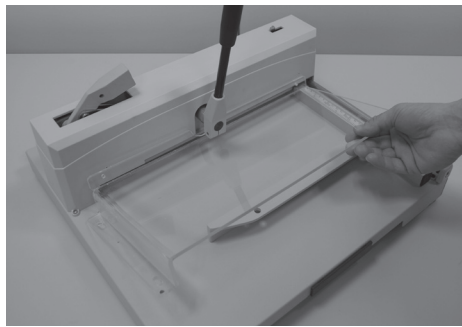
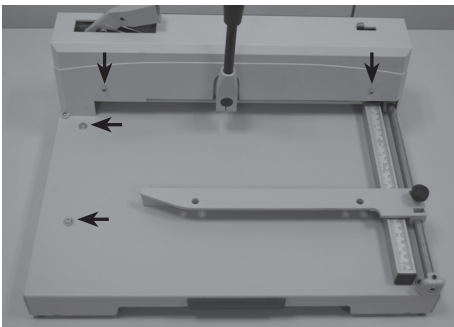

Fig. 1

Fig. 2

Fig. 3

Remove the four screws indicated in fig 1. Insert the rear safety cover with the notch under the clamping lever arm (fig. 2). Attach the rear safety cover by reinstalling the screws (fig 3).

Blade Lever Arm

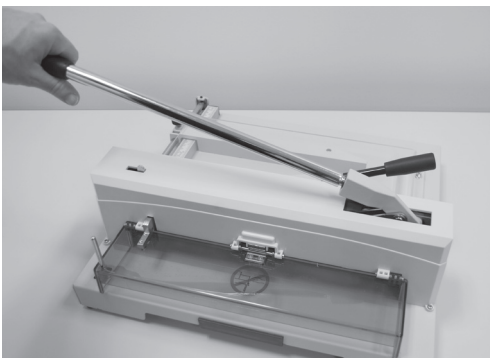

Screw the blade lever arm into the lever arm base and hand tighten.

Batteries



Install the two "C" batteries for the laser light into the holder on the underside of the cutter.

OVERVIEW

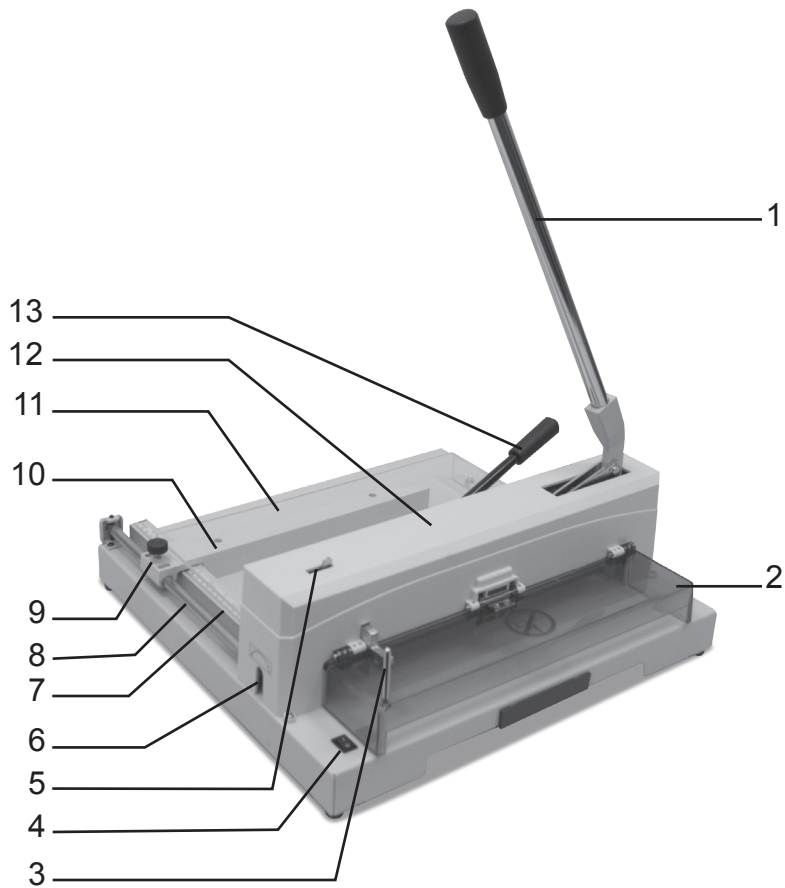

1. Blade lever arm
2. Front safety guard
3. Blade lever locking safety arm
4. LED laser light switch
5. Blade lever safety release
6. Blade adjustment
7. Back gauge scale
8. Back gauge slide
9. Back gauge adjustment thumbscrew
10. Back gauge
11. Rear safety cover
12. Blade housing cover
13. Clamping lever
14. Blade carrier
15. Cutting stick
16. Cutting blade
17. Blade change safety tools
18. "T" handle Allen wrench

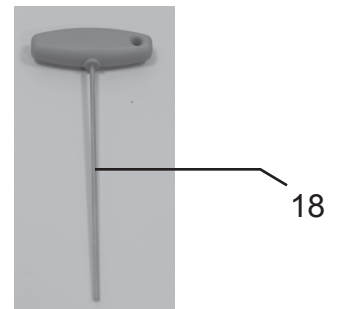
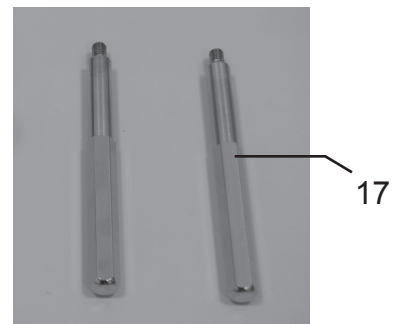
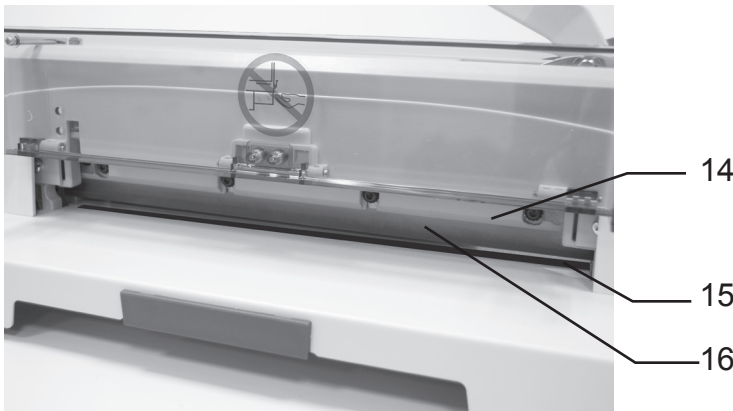

DESCRIPTION OF EQUIPMENT PARTS

1.	Blade Lever Arm	Lever-action provides robust cutting with minimal effort. After each cut, the lever must be returned to its full upright and locked position.
2.	Front Safety Guard	Prevents operators from placing hands or other objects in the cutting area. Must be in the lowered/closed position in order to operate the cutter. The guard can only be reopened when the knife lever is in the upright, locked position.
3.	Blade lever locking safety arm	Locks the blade lever arm safety release in position when the front safety guard is open.
4.	LED laser light switch	Turns the laser light beam on and off.
5.	Blade lever safety release	Locks the blade in the open position. Slide the safety lever to the left to lower the blade lever arm.
6.	Blade adjustment access	The blade height can be adjusted up to 2mm by using the adjustment screw. To lower the blade (+), turn to the left. To raise the blade (-), turn to the right. NOTE: If the blade is adjusted too low, it will cut deeply into the cutting stick, damaging not only the stick but the cutting blade. The optimal blade height is when the bottom sheet in a stack is cut accurately.
7.	Back gauge scale	In mm/cm and inches.
8.	Back gauge slide	Guides the back gauge forward and back.
9.	Back gauge adjustment thumb-screw	Loosen the thumbscrew to move the back gauge forward and backward.
10.	Back gauge	Moved by loosening the back gauge thumbscrew. Used to move the paper stack to the appropriate cutting position and to safely remove paper from the cutter.
11.	Rear safety cover	Clear acrylic cover is provided for operator safety and helps to prevent dust buildup.
12.	Blade housing cover	Attached to the machine with 5 screws. Only disassemble in case of blade change or maintenance. Before removing the cover, the blade lever arm must be removed.
13.	Clamping lever	Lowers the clamping device that holds the paper stack firmly in position.
14.	Blade carrier	Holds the blade during operation. Blade is attached with 4 screws.
15.	Cutting stick	Plastic stick which protects the edge of the blade during cutting. Can be rotated and repositioned to be used up to 8 times before being replaced.
16.	Cutting blade	Heat-treated high-carbon steel blade.
17.	Blade change safety tools	Used to safely remove the blade when it needs to be re-sharpened or replaced.
18.	"T" handle Allen wrench	Used to adjust blade and remove cutting stick

OPERATION

1. Turn on the LED Laser Light.
2. Raise the blade lever arm to the upright, locked position.

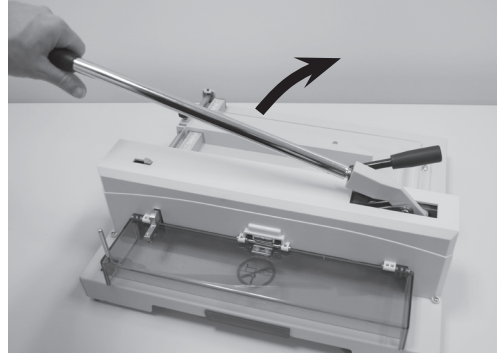

3. Loosen the back gauge thumbscrew and slide the back gauge forward or back to set it for the correct paper length then re-tighten the thumbscrew. The back gauge scale is marked for both standard and metric measurements.



4. Raise the front safety cover. Slide the paper stack into the cutter along the left edge, using the alignment bar for guidance. Push it as far back as possible toward the back gauge, without placing hands under the cutting blade.

Important Note: When cutting pieces less than 2" insert the longer side of the document for safe removal after cut.

5. Lower the front safety cover.

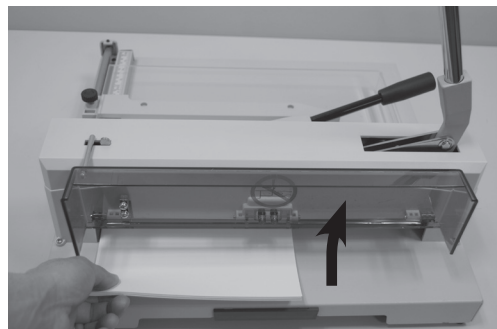

6. Move the clamping lever to the left to lower the clamp and secure the paper in place.

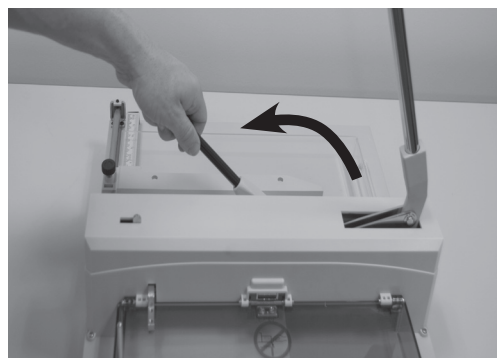

7. Grasp the blade lever arm and lower it slightly while at the same time sliding the safety lever to the right (inset) to engage the blade lever arm.

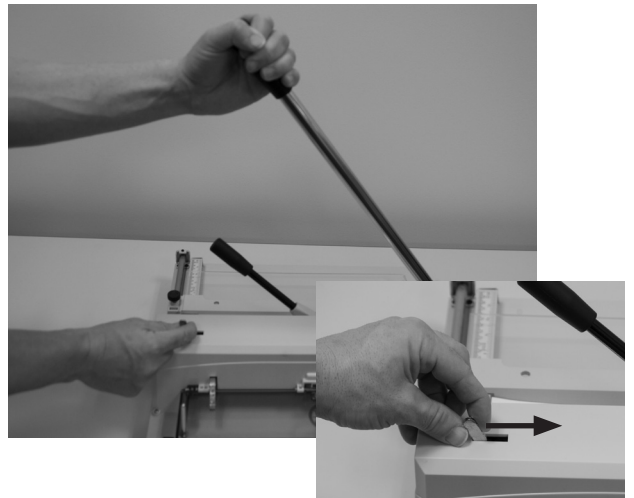

8. Use both hands to grasp the blade lever arm and bring it down to cut through the paper stack. When the cut is complete, raise the lever arm to its top position until it locks into place.

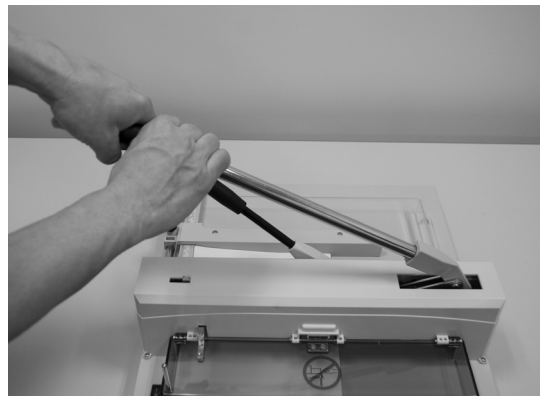

9. Move the clamping lever to the right to raise the clamp and release the paper.

10. Lift the front safety cover.

11. Loosen the back gauge thumbscrew and slide the back gauge forward to safely remove the paper.

Important Note: When cutting pieces less than 2" insert the longer side of the document for safe removal after cut.

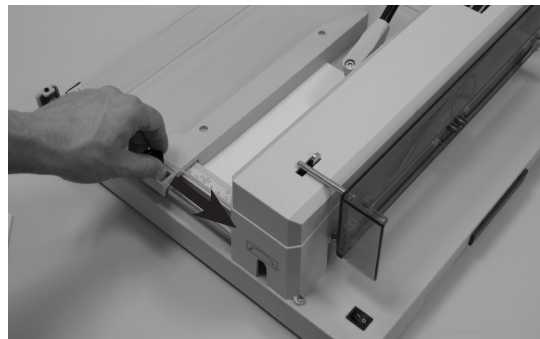

MAINTENANCE

All moving parts with screws should be checked periodically to be sure the screws are tight. They may become loose in the process of transportation. Users should also check and tighten the screws after more than 200 cutting cycles.

All moving parts should be lubricated and oiled periodically to maintain performance and equipment life. Before lubricating, these parts should be cleaned to remove paper dust and old deposits of oil and grease.

REPLACING THE CUTTING STICK

The cutting stick is the surface the blade contacts during the cutting process. It can be turned or rotated and used twice on each side, 8 times altogether.

If the last piece of paper in the stack is not cut through cleanly, and the blade height has been adjusted properly, the cutting stick should be turned, rotated or replaced.

The cutting stick sits in a channel in the base of the cutter. To remove the stick, insert the "T" red-handled Allen wrench tool into the hole in the end of the cutting stick through the opening on the left side of the blade housing cover and lift the stick up and out. Turn the stick 180 degrees to use the same cutting side, or rotate to a new side if the first has already been used twice.

NOTE: When the cutting stick is rotated or replaced, the blade height must be readjusted. A blade which cuts too deeply damages not only the cutting stick but the blade itself. The optimal blade height is when the last sheet in a stack is cut accurately. The blade height can be adjusted up to 2mm by using the adjustment screw located on the left side of the cutting head. To lower the blade (+), turn to the left. To raise the blade (-), turn to the right.



Cutting stick

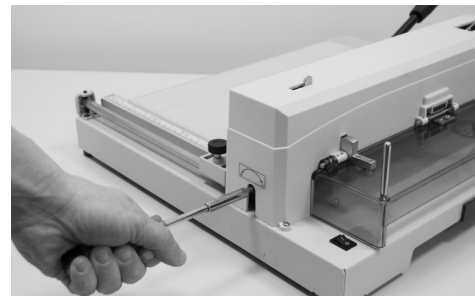

CUTTING BLADE MAINTENANCE

The cutting blade is made of heat-treated high-carbon steel and is designed for repeated use. However, over time the blade will become dull, and not perform to the highest standards. Cutting heavy paper or cardboard will dull the blade more quickly than thinner paper stock. A dull blade will not cut accurately. If the blade jams in the paper stack or leaves a groove in the paper, it should be changed immediately.

If the blade is not making clean, accurate cuts, check the following:

- * Have you rotated or replaced the cutting stick?
- * Have you correctly adjusted the height of the blade?

If so, the blade will need to be replaced. The blade can either be re-sharpened by a professional, or it can be replaced with a new blade. To avoid injury, follow the Blade Changing Procedure and use the Blade Change Safety Tool, included with the cutter.

REPLACING THE CUTTING BLADE

1. Remove the blade lever arm and the blade housing cover. Then reinstall the blade lever arm.



2. Lower the blade lever arm.
3. Remove the two middle blade screws and install the blade carrier tools.

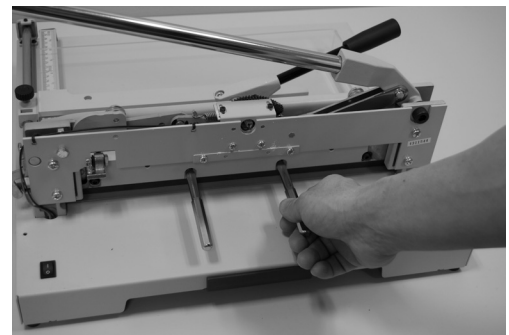
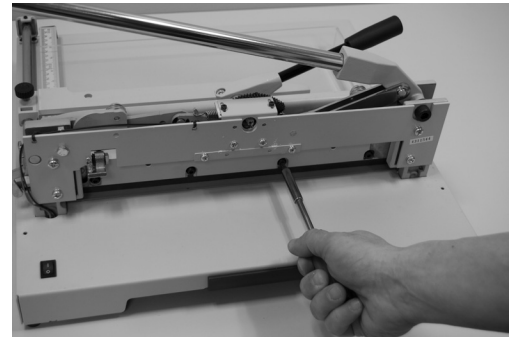

4. Remove the two outer screws.
5. Raise the blade lever arm.
6. Slowly turn the handles of the safety tool slightly to the left, just enough to release the blade from the machine. Then carefully remove the blade.

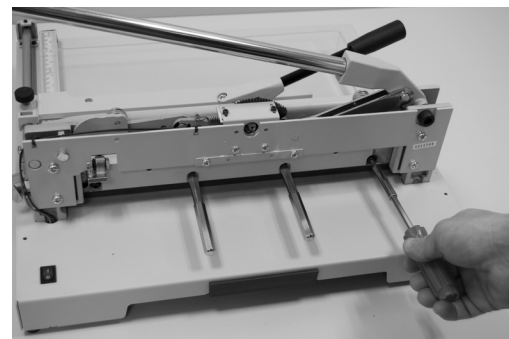

7. Carefully remove the old blade from the blade change tools. Set the blade on a flat surface and unscrew the handles. Cap the old blade with a protective pad to prevent injury.

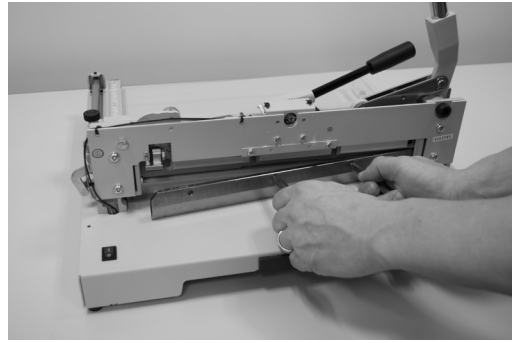

8. Place the new blade with the beveled cutting edge facing up, and the screw holes at the top, as shown here. Remove the protective pad from the new blade.

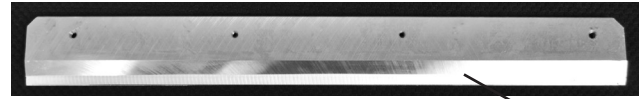

Attach the blade change tools to the new blade. Do not screw the blade tools all the way in, there needs to be enough of a gap approx. 1/4" so the blade can be slid back into position. Then reverse the procedure to install the new blade.

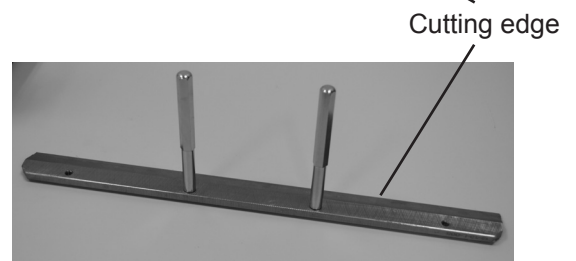

9. After installing the new blade, it will need to be adjusted for proper positioning and cutting depth.
10. Carefully move the blade to the cutting stick by lowering the blade lever arm. NOTE: Keep hands and objects out of the path of the blade.
11. Turn the blade adjustment screw (X) to the right (-) until you have a visible ray of light between the blade and the cutting stick.
12. Adjust the blade to touch the cutting stick evenly by using the two screws at the top (Y).
13. Raise the blade lever arm to the top position and lock it. Then make a trial cut with a single sheet of paper. If the paper is not cut through completely, the blade must be adjusted using the screws (X) and/or (Y).
NOTE: The two (Y) screws are for horizontal adjustment and the (X) screw is for minor up-down adjustment.
14. Reassemble the blade housing cover, the front safety cover, and reattach the the blade arm lever.

